



BENDER  
CONNECT

# COMTRAXX® CP305 - Control Panel

Remote alarm indicator for medical locations and other areas





## Table of contents

<b>1</b>	<b>General information.....</b>	<b>6</b>
1.1	How to use the manual.....	6
1.2	Indication of important instructions and information.....	6
1.3	Signs and symbols.....	6
1.4	Service and Support.....	6
1.5	Training courses and seminars.....	6
1.6	Delivery conditions.....	7
1.7	Inspection, transport and storage.....	7
1.8	Warranty and liability.....	7
1.9	Disposal of Bender devices.....	7
1.10	Safety.....	8
<b>2</b>	<b>Intended use.....</b>	<b>9</b>
<b>3</b>	<b>Product description.....</b>	<b>10</b>
3.1	Scope of delivery.....	10
3.2	Device features.....	10
3.3	System description.....	11
3.4	Interfaces.....	12
<b>4</b>	<b>Mounting.....</b>	<b>14</b>
4.1	Dimension diagram CP305.....	14
4.2	Flush-mounting.....	14
4.3	Surface mounting.....	17
4.4	Retrofit: Replacement of MK2430.....	18
<b>5</b>	<b>Connection.....</b>	<b>19</b>
5.1	Safety instructions.....	19
5.2	Connection diagram.....	21
5.3	Ethernet connection.....	23
5.4	Digital inputs and relay outputs.....	23
<b>6</b>	<b>Commissioning.....</b>	<b>25</b>
<b>7</b>	<b>Software update.....</b>	<b>27</b>
<b>8</b>	<b>Factory settings for communication.....</b>	<b>28</b>

<b>9</b>	<b>Display and operation.....</b>	<b>29</b>
<b>10</b>	<b>Display CP305: Menu structure.....</b>	<b>31</b>
10.1	Measured values.....	31
10.2	Bus overview.....	31
10.3	History.....	31
10.4	Alarm and test.....	33
10.5	Settings.....	33
10.6	Info.....	37
<b>11</b>	<b>Web user interface: menu structure (via ETH socket).....</b>	<b>38</b>
11.1	COMTRAXX® user interface.....	38
11.1.1	Header.....	38
11.1.2	Navigation.....	39
11.1.3	Subnavigation.....	39
11.1.4	Content section.....	39
11.1.5	Alarm overview (footer).....	40
11.2	Start.....	40
11.3	System overview.....	40
11.3.1	Device tools.....	40
11.3.2	Menu.....	41
11.3.3	BMS.....	41
11.4	Alarm overview (footer).....	41
11.5	Tools.....	42
11.5.1	Monitoring.....	42
11.5.2	Device management.....	43
11.5.3	Service.....	44
11.5.4	Information.....	44
<b>12</b>	<b>Web user interface: Settings (via ETH socket).....</b>	<b>45</b>
12.1	Digital inputs 1-12.....	45
12.2	Relays 1-2.....	46
12.3	Interface.....	46
12.4	Individual texts.....	46
12.5	History.....	47
12.6	Clock.....	47
12.7	Display.....	47
12.8	Security.....	47
12.9	Buzzer.....	48

12.10	Service inspection.....	48
12.11	Factory setting.....	49
<b>13</b>	<b>Web user interface: Menu structure (access via gateway).....</b>	<b>50</b>
13.1	Device tools.....	50
13.2	Menu.....	50
13.2.1	Edit texts.....	50
13.2.2	Info.....	51
<b>14</b>	<b>Export and import of device data.....</b>	<b>52</b>
<b>15</b>	<b>Cleaning, servicing and troubleshooting.....</b>	<b>53</b>
15.1	Cleaning.....	53
15.2	Servicing.....	53
15.3	Error messages.....	53
15.4	LED.....	53
15.5	Malfunctions.....	54
15.6	Recurring inspections.....	54
<b>16</b>	<b>Technical data.....</b>	<b>56</b>
16.1	Tabular data.....	56
16.2	Standards and approvals.....	60
16.3	Ordering information.....	60
16.4	Document revision history.....	61
<b>17</b>	<b>EU Declaration of Conformity.....</b>	<b>62</b>

## 1 General information

### 1.1 How to use the manual



#### ADVICE

This manual is intended for qualified personnel working in electrical engineering and electronics! Part of the device documentation in addition to this manual is the enclosed supplement "Safety instructions for Bender products".



#### ADVICE

Read the operating manual before mounting, connecting and commissioning the device. Keep the manual within easy reach for future reference.

### 1.2 Indication of important instructions and information



#### DANGER

Indicates a high risk of danger that will result in death or serious injury if not avoided.



#### WARNING

Indicates a medium risk of danger that can lead to death or serious injury if not avoided.



#### CAUTION

Indicates a low-level risk that can result in minor or moderate injury or damage to property if not avoided.



*Information can help to optimise the use of the product.*

### 1.3 Signs and symbols



Disposal



Protect from moisture



Protect from dust



Temperature range



Recycling



RoHS directives

### 1.4 Service and Support

Information and contact details about customer service, repair service or field service for Bender devices are available on the following website: Fast assistance | Bender GmbH & Co. KG.

### 1.5 Training courses and seminars

Regular face-to-face or online seminars for customers and other interested parties:

[www.bender.de](http://www.bender.de) > know-how > seminars.

## 1.6 Delivery conditions

The conditions of sale and delivery set out by Bender GmbH & Co. KG apply. These can be obtained in printed or electronic format.

The following applies to software products:



'Software clause in respect of the licensing of standard software as part of deliveries, modifications and changes to general delivery conditions for products and services in the electrical industry'

## 1.7 Inspection, transport and storage

Check the shipping and device packaging for transport damage and scope of delivery. In the event of complaints, the company must be notified immediately, see "www.bender.de > service & support".

The following must be observed when storing the devices:

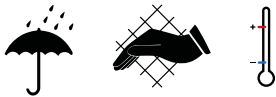

## 1.8 Warranty and liability

Warranty and liability claims for personal injury and property damage are excluded in the case of:

- Improper use of the device.
- Incorrect mounting, commissioning, operation and maintenance of the device.
- Failure to observe the instructions in this operating manual regarding transport, commissioning, operation and maintenance of the device.
- Unauthorised changes to the device made by parties other than the manufacturer.
- Non-observance of technical data.
- Repairs carried out incorrectly.
- The use of accessories or spare parts that are not provided, approved or recommended by the manufacturer.
- Catastrophes caused by external influences and force majeure.
- Mounting and installation with device combinations not approved or recommended by the manufacturer.

This operating manual and the enclosed safety instructions must be observed by all persons working with the device. Furthermore, the rules and regulations that apply for accident prevention at the place of use must be observed.

## 1.9 Disposal of Bender devices

Abide by the national regulations and laws governing the disposal of this device.



For more information on the disposal of Bender devices, refer to [www.bender.de](http://www.bender.de) > service & support.

## 1.10 Safety

If the device is used outside the Federal Republic of Germany, the applicable local standards and regulations must be complied with. In Europe, the European standard EN 50110 applies.



**DANGER** ***Risk of fatal injury due to electric shock!***

*Touching live parts of the system carries the risk of:*

- Risk of electrocution due to electric shock
- Damage to the electrical installation
- Destruction of the device

Before installing the device and before working on its connections, make sure that the installation has been de-energised. The rules for working on electrical systems must be observed.



## 2 Intended use

Remote alarm indicator COMTRAXX® CP305 is used for visual and audible signalling of operating and alarm messages from the Bender systems MEDICS®, ATICS®, EDS and RCMS. In MEDICS® monitoring systems, the CP305 meets the requirements of standard DIN VDE 0100-710 with regard to test functions for IT system monitoring and alarms from changeover devices. IT system monitoring equipment are tested via the test button and the devices to be tested.

Important display functions

- Normal operation indicator
- Insulation fault
- Overload
- Overtemperature
- Interruption of the system conductor or PE conductor connection of the ISOMETER®
- Supply line failure
- Power supply fault conditions and changeover device faults
- Device failure
- Test results
- Measured values

The connection between the CP305 and the transfer switching and monitoring modules is implemented with bus technology. During normal operation, the CP305 indicates the readiness for operation of the system.

CP305 features 12 digital inputs, allowing messages from other technical equipment to be recorded and displayed on the CP305, such as from medical gases or battery-supported safety power supply systems (BSV systems). Two relay contacts enable messages to be forwarded to the higher-level building management system (BMS).

CP305 devices are used in

- Healthcare facilities
- Industrial and office buildings
- Public buildings

Please heed the limits of the area of application indicated in the technical specifications.

Operator control and adjustment of settings is partly done directly on the device or in a web browser.

Any other use than that described in this manual is regarded as improper.

Intended use includes:

- Equipment-specific settings compliant with local equipment and operating conditions
- Observation of all information in the operating manual
- Compliance with test intervals

## 3 Product description

### 3.1 Scope of delivery

You get

- Remote alarm indicator CP305
- Connection plug kit (power supply, RS485 connection)
- Connections for the digital inputs and relay outputs
- A printed quick reference guide  
The manuals are available at: <https://www.bender.de/en/service-support/download-area/>
- Safety instructions for Bender products

Installation options

- Flush-mounting (flush-mounting enclosure B923710)
- Surface mounting (surface-mounting enclosure B95100153)
- Cavity wall mounting (cavity wall mounting set B923711)
- Retrofit (CP305 can be inserted directly into existing MK2430 flush-mounting enclosure; other devices on request)

### 3.2 Device features

#### Characteristics

On its display, the CP305 shows the messages of all BMS bus participants that have been assigned to it via alarm addresses. As well as being used as a standalone indicator, a CP305 also supports parallel indication of several CP305 in different rooms.

Parameters can be set for the alarm colours for the LED (e.g. red for an alarm, yellow for a warning such as an insulation fault or the like).

In case of a message, there is an alarm pop-up (display). This is in addition to the LED as well as an entry in the alarm overview (web user interface). An audible signal for which parameters can be set also sounds (can be acknowledged/can be muted).

If a second message is received while the first is still pending, the audible signal will sound again and the messages appear alternately on the display. The address of the device triggering the alarm can also be displayed. The audible signal sounds again once a configurable period of time has elapsed (repetition can be deactivated).

Internal device parameters (alarm addresses, test addresses...). Parameters can be set for individual message texts for each alarm and test address. The CP305 can be used as a master device in installations with several IT and EDS systems.

The "TEST" button can be used to check the function of the associated devices such as insulation monitoring devices, LIM (Line Isolation Monitors) and GFCI (Ground Fault Circuit Interrupters). A message is only sent to the CP305 on which the test was started. The test and its individual evaluations are carried out sequentially. Finally, a message appears that the test was successful or an error message will be output.

The CP305 has the following features

- Display of operating status, warning and alarm messages according to DIN VDE 0100-710, IEC 60364-7-710 and other standards
- 12 digital inputs
- 2 relay contacts (changeover contact)

- Plain text display with illuminated 5" touch display
- Easy to clean and disinfect, degree of protection IP54 (entire device) or IP66 (front glass pane)
- Front panel mounted without screws
- User-friendly, touch-sensitive monitoring system for medical areas and other applications
- Particularly simple operator guidance
- Additional information for medical and technical personnel
- Visual and audible notification in the event of an alarm
- Clear menu structure
- Silent due to fan-free operation
- High-quality display with excellent contrast, high resolution and a wide-viewing angle
- Device tests and parameter setting changes with minimal service interruptions
- Standard texts for messages in the national language
- 500 freely programmable alarm messages
- Bus technology for easy installation and reduced fire load
- Audible alarm (can be acknowledged or muted)
- Version for flush mounting and surface mounting
- Easy putting into service due to predefined alarm text messages
- History memory with real-time clock to store 1000 warnings and alarms
- Power supply via power supply unit
- Parameter setting via Ethernet interface
- NFC interface for connection to the Bender Connect app
- Replacing MK2430 (retrofit); other devices on request

### **Applications**

- Visualisation on the display optimally tailored to the user
- Integration of all compatible Bender products (MEDICS®, ATICS®, EDS, Linetraxx® RCMS systems and ISOMETER®)
- Individual instructions for action in the event of alarms

## **3.3 System description**

### **Certification**

COMTRAXX® CP305 are UL certified.

### **MEDICS®**

The CP305 remote alarm indicators are components of the MEDICS® systems. MEDICS® is an intelligent system that guarantees safe power supply in medical locations.

### Connection example BMS

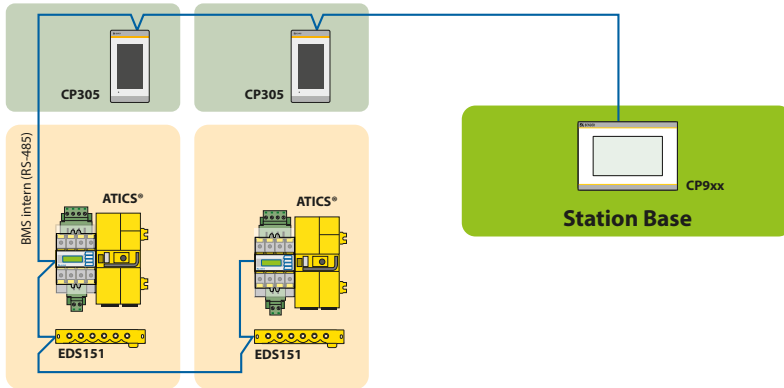

In the example, the ICU is monitored from the station base via BMS bus.

### Connection example BMS and Ethernet

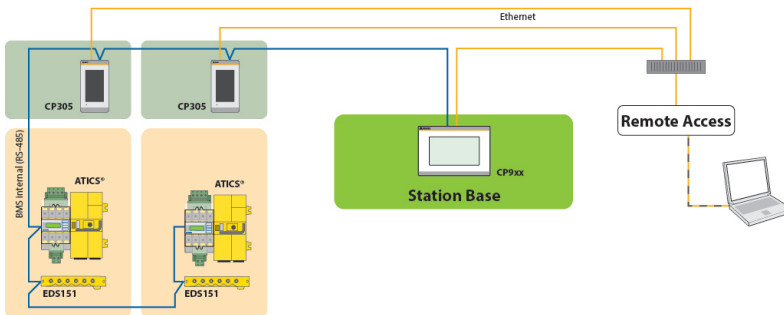

In the example, the ICU can be monitored from the station base. In addition, remote maintenance is possible via the building services or Bender.

## 3.4 Interfaces

### BMS

The BMS bus is used for communication with BMS bus nodes or devices like RCMS..., EDS..., SMI..., SMO..., ATICS®, alarm indicator and operator panels. The CP305 acts as the master whenever the address is set to 1 and as CP305 slave when the address is set between 2 and 90.

The master controls the data traffic on the BMS bus.



- Remote alarm indicator CP305 is to be operated as a master if*
  - Parameters are queried or changed.
  - Certain control commands were given.

## Addressing

For remote alarm indicator CP305 to function properly, it must be correctly addressed.

## Terminating resistor

For correct functioning of the CP305 remote alarm indicator, its correct termination is of fundamental importance. The first and last device on the BMS bus must be terminated with a terminating resistor (daisy chain). If the CP305 is to be terminated, the terminating resistor is switched on with a dip switch on the bottom of the device.

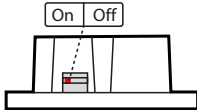

Dip switch on the bottom of the CP305

## Ethernet

Using the RJ45 interface "ETH", the CP305 can be addressed via Ethernet. The web server required for this is included in the device. The configured IP address can be found on the device under  > Info.

The web user interface can be used to adjust all device settings.

## NFC (near-field communication)

The powered device can also have its parameters set via NFC. The interface is activated on the CP305 under  > Settings > Interface > NFC. Afterwards, the prepared configuration can be loaded onto the device using the Bender Connect app.

## 4 Mounting

### 4.1 Dimension diagram CP305

All dimensions are in mm.

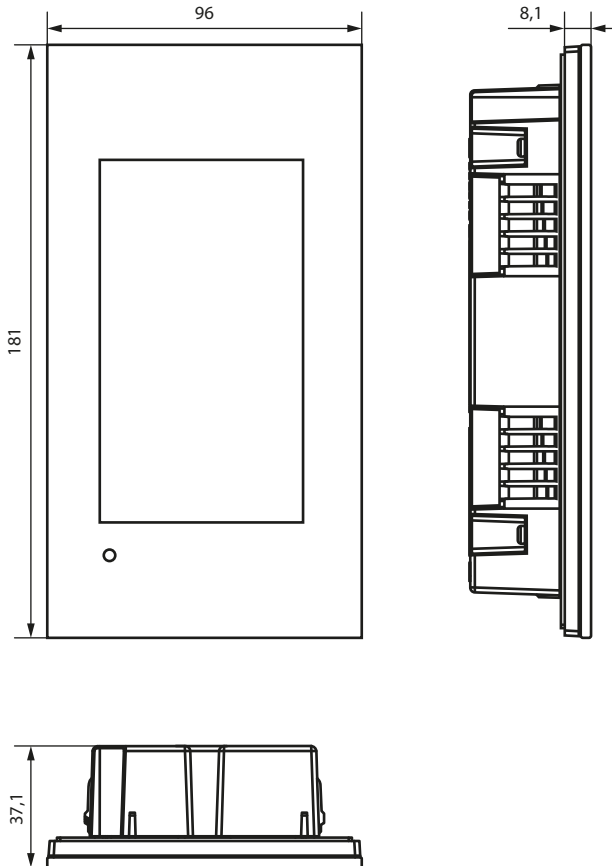

### 4.2 Flush-mounting



*The flush-mounting enclosure is optionally available (B923710).*

**Dimension diagram flush-mounting enclosure**

All dimensions are in mm.

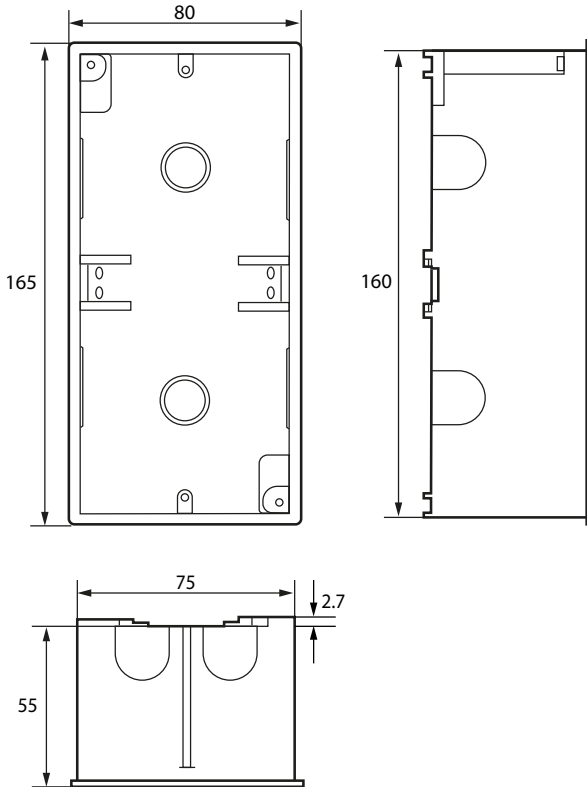

### Installation of flush-mounting enclosure

1. Insert the supplied cardboard into the flush-mounting enclosure to provide protection against pollution.
2. Insert the enclosure so that it is flush with the wall surface.

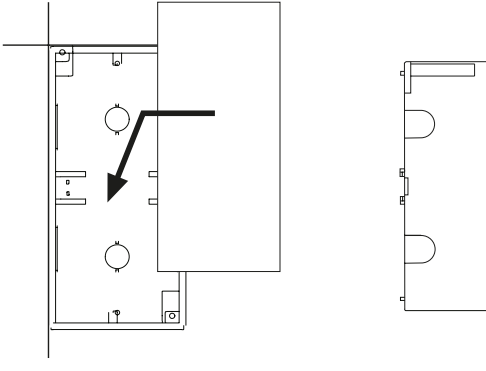

The flush-mounting enclosure must not be installed lopsidedly or warped, and must not be installed too deep below the surface.

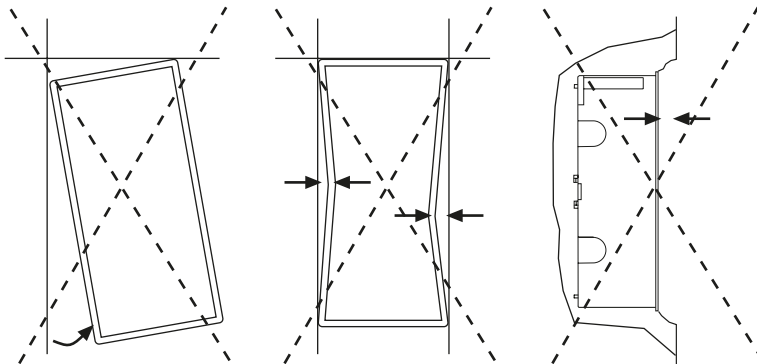



### 4.3 Surface mounting

For surface mounting, the matching surface-mounting enclosure (item no. B95100153) must be used. All dimensions are in mm.

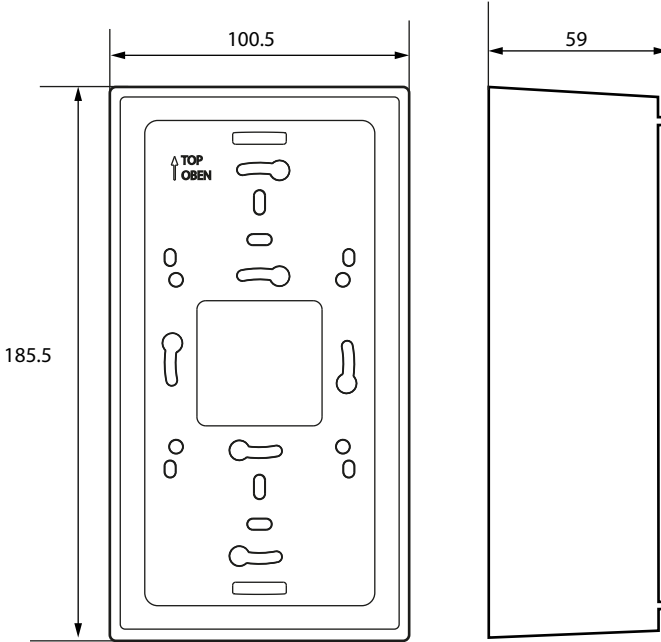

### Cavity wall and panel mounting

For cavity wall or panel mounting, you need the "Cavity wall mounting set" (item no. B923711).

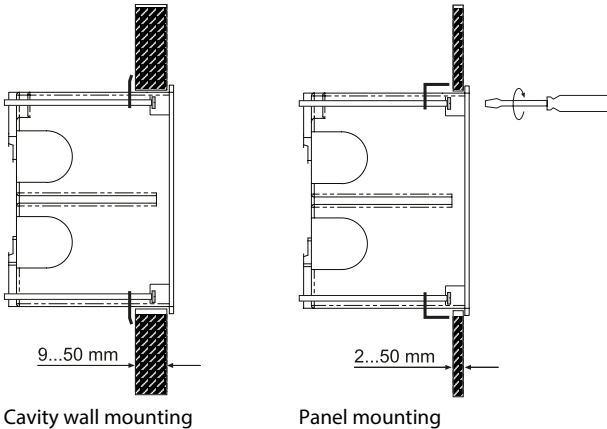

#### 4.4 Retrofit: Replacement of MK2430

In the context of retrofit measures, CP305 can be installed directly in the existing flush-mounting MK2430 enclosures.

**i** *If MK2418, MK2410 or other devices are to be replaced, the flush-mounting enclosures must be changed. Please contact Bender Service for details.*

## 5 Connection

### 5.1 Safety instructions



Only skilled persons are permitted to carry out the work necessary to install, put into service and run a device or system.



#### **DANGER** *Danger of electric shock!*

Follow the basic safety rules when working with electricity. Observe the information on rated voltage and supply voltage specified in the technical data!



#### **DANGER**

Connect the CP305 exclusively according to the connection diagram in this chapter. Do not make any changes to the internal wiring. Non-compliant connection or arbitrary changes can lead to serious malfunctions or even complete failure of the CP305.



#### **CAUTION**

##### **Electrostatic discharge sensitive devices**

Observe the precautions for handling electrostatically sensitive devices.

##### **Damage to components**

Do not remove the device from the enclosure while it is in operation. Disconnect the device from the power supply and the network (Ethernet) beforehand.

##### **Damage to the device due to incorrect connection plug**

Connectors of other devices may have polarity that differs. You are required to use the enclosed connector plug (A1/+, A2/-).

##### **Safe separation**

The power supply must be properly insulated from hazardous voltages and meet the limits of UL/CSA 6101010-1 (6.3).



*To comply with the requirements of DIN VDE 0100-710, AC power supplies with max. 25 VAC must be used.*



*All enclosed connectors should always be plugged in even when they are not in use.*

#### **PELV**

If a DC power supply unit is used to supply one or more CP305 devices, A2/- can be connected to protective earth. **Then shielded Ethernet cables can also be used.**

#### **SELV**

If an AC or DC power supply without a secondary connection between A2/- and protective earth is used to supply one or more CP305 devices, **unshielded Ethernet cables must be used.**

## Notes on the connection

**Supply voltage**

- Connect the CP305 devices to the supply voltage (terminals A1/+, A2/-).
  - **DC 24 V:** Take the line voltage drop into account if you are using long supply cables for the supply voltage. Consider the maximum permissible cable lengths for the supply voltage (A1/+, A2/-) (see "Technical data").

**Ethernet**

- The currently configured IP address can be read out in the device under  > Info. The IP address for a 1:1 connection is unique for each device and derived from the MAC address when the device is started.

**BMS bus**

- The connection to the internal BMS bus is established via terminals BMS A/BMS B. Connect the BMS bus. Use a shielded and twisted cable with a diameter of at least 0.8 mm for the interface line (e.g. CAT6/CAT7 min. AWG23). Connect the shield to earth at one end. Please note that when routing the supply voltage  $U_S$ , a 4-wire cable (2 x BUS, 2 x  $U_S$ ) with suitable cross section is required.
- The first and last device on the BMS bus must be terminated with a terminating resistor. Use the DIP switch on the bottom of the CP305 to set the terminating resistor for the BMS bus (factory setting: off).
- For more information, see the BMS bus manual (D00276).

**Digital inputs/relay outputs**

- Use cables with a cross section of at least 0.75 mm<sup>2</sup> when connecting the digital inputs and the relay outputs.
- The maximum cable length per connection is 500 m.

## 5.2 Connection diagram

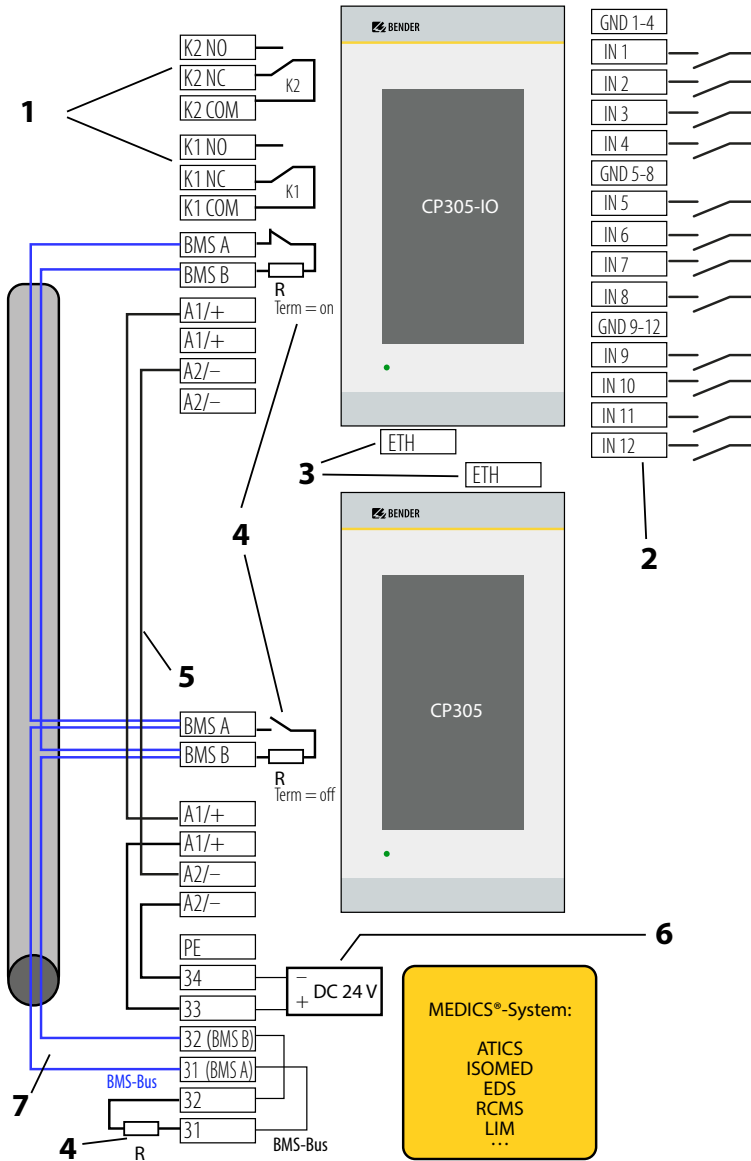

Legend for the connection diagram

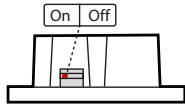
No.	Terminal	Explanation	
1	K...COM K...NC K...NO	<b>2 relay outputs</b> Parametrisable contacts for device errors, test of assigned devices**, device failure and common alarm message.	
2	IN1...12 GND...	<b>Digital inputs</b> The digital inputs are divided into three groups of four, which are galvanically separated from each other and from the device. Each group has its own GND terminal for the reference potential. If the inputs are controlled via an external voltage, the common reference potential is connected to the "GND" terminal and the signal is connected to the respective input IN1...12.	
3	ETH	<b>Ethernet interface</b> for connection of a PC The CP305 can be integrated into the Bender/hospital network via the Ethernet interface. Parameters can be set on the PC, and data as well as the history memory can be read out. Connected measuring devices can be displayed with their channels.	
4	R	<b>Terminating resistor of BMS bus</b> If two or more devices are connected to each other via the BMS bus, the bus line must be terminated at both ends with a resistor ( $R = 120 \Omega$ ) (can be switched on via dip switch on the underside of the CP305).	
5	A1+/A2-	<b>Supply voltage</b> Adhere to the permissible cable lengths and cross sections when supplying the CP305 in the MEDICS® modules.	
6	DC 24 V	<b>power supply unit</b> in the MEDICS® module, sufficient for supplying power to up to two CP305 devices.	
7	BMS A BMS B	<b>BMS bus connection</b> (see also D00276) Cable: Shielded, one end of shield connected to PE Recommended CAT6/CAT7 min. AWG23 Alternatively Cable, twisted pairs, J-Y(St)Y min. 2x0.8 Connect shield to PE on one side Various Bender devices with a BMS bus interface. Examples: ATICS, ISOMED427P, EDS151, RCMS..., CP9xx, ...	

\*\* Devices without BMS bus connection, but with test input (e.g ISOMETER®)

**Connection assignment (rear)**

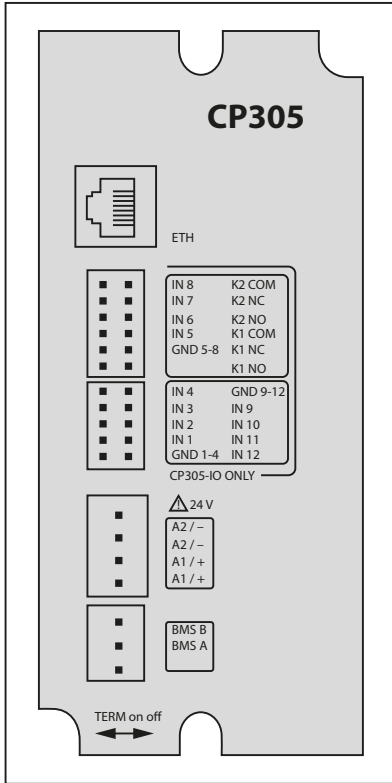

The connections are located on the back of the device.

The dip switch for terminating the BMS bus is located on the bottom of the device:

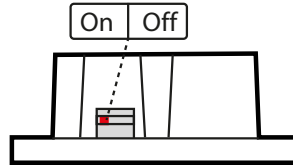

**5.3 Ethernet connection**

An RJ45 socket insert and a Cat.6 SLIM patch cable are included in the connector kit (item no. B95100152).

**i** *The CP305 cannot be connected with a standard RJ45 cable with a rigid connector without the connector kit.*

**5.4 Digital inputs and relay outputs**

The CP305 is intended for use in basic (DIN EN 61326-1, Table 1) and industrial (DIN EN 61326-1, Table 2) electromagnetic environments.

CP305 devices have 12 digital inputs (DI) for which parameters can be set and 2 relay outputs for which parameters can be set. The settings are made in a browser using the web user interface.



**CAUTION**

In industrial electromagnetic environments/applications, the digital inputs and relays of the CP305 must not be connected directly to the power supply network.

### Operating mode digital inputs

The choices are “off”, “High-active”, “Low-active”.

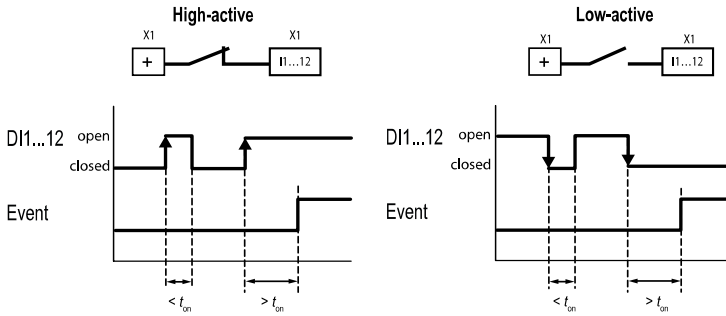

#### High-active (N/C)

An event is executed when the digital input experiences an edge change from low to high. Response time  $t_{on}/t_{off}$  after a switch-on signal.

#### Low-active (N/O)

An event is executed when the digital input experiences an edge change from high to low. Response time  $t_{on}/t_{off}$  after a switch-off signal.

#### Response times $t_{on}/t_{off}$

- on The response time  $t_{on}$  after a switch-on signal can be adjusted from 0 ms ... 10 minutes
- off The response time  $t_{off}$  after a switch-on signal can be adjusted from 0 ms ... 10 minutes

### Relay

CP305 has 2 relay outputs (changeover contacts K1 and K2) for which parameters can be set. They can be used to forward error, test or (collective) alarm messages to a building management system.

### Data traffic via Modbus TCP

The 12 digital inputs as well as the 2 relays can be accessed via Modbus TCP.

Register	Property	Format	Description
4096	RO	UINT16	Output of the digital inputs IN1...12 as bit mask
4097	RO	UINT16	Digital input IN1
4098	RO	UINT16	Digital input IN2
...			
4108	RO	UINT16	Digital input IN12
4109...4111	Reserved		
4112	RO	UINT16	Output of both relays as a bit mask
4113	RO	UINT16	Relay K1
4114	RO	UINT16	Relay K2



## 6 Commissioning

### Commissioning assistant

During initial putting into service or after a reset to factory settings, the putting-into-service wizard opens for the basic setup steps.

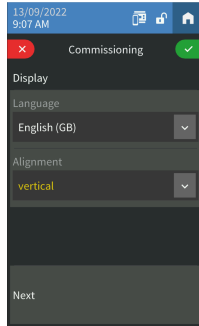

The putting-into-service wizard launches in English. The header is blue, and the LED is green.

You need to log in to the device (with the PIN via the  icon in the header). Only then are changes possible. Use the drop down menus to change entries. Changes are confirmed (green) or discarded (red) at the top of the display.

You can exit the putting-into-service wizard at any time  if you click the icon in the header. Changes that have already been made are not discarded.

- i** *Address settings:*  
 If several parameters can be changed in one box, first touch one of the positions. This is now highlighted in white and can be set to the correct value with the arrow keys. Repeat these steps until the parameters are correctly set for the address.  
 Changes are confirmed (green) or discarded (red) at the top of the display.

The following basic settings are requested and can be set:

#### Display

- Language
- Alignment

#### BMS

- BMS address (1 = master)

#### Ethernet

The IP address that is currently set is displayed.

- DHCP (on/off)
- IP address
- Subnet mask
- Standard gateway

“Complete” will complete the initial setup of the device.

**i** *If no test or alarm addresses have been set up, you will receive a message to this effect. You can use the web user interface to configure these addresses.*

You can configure additional settings on the display or the web user interface on the PC.

### NFC (near-field communication)

The powered device can also have its parameters set via NFC. The interface is activated on the CP305 under  > Settings > Interface > NFC. Afterwards, the prepared configuration can be loaded onto the device using the Bender Connect app.

Electromagnetic disturbances may affect the NFC dialog between the CP305 and an external NFC transceiver.



The NFC interface can be used to transmit a previously configured device parameter setting directly to the device.

**i** *This function is available only via the Bender Connect App. You can find this app in the Appstores for iOS and Android.*



In the Bender Connect app the device first needs to be made known. Then the device-specific setting options are shown so that they can be configured. When the data is transferred, feedback is given whether the parameter configuration has been successful.



Parameter settings can be transmitted to the device via the Bender Connect app by holding the mobile phone close to the device.

To a **de-energised** device, a parameter setting can be transferred via the Bender Connect app. This setting is then activated automatically when the device is connected to the current supply.



When a device is **plugged in**, too, parameters can be configured via the Bender Connect App. To this end, the NFC interface first needs to be activated in the device.

## 7 Software update

The CP305 software is subject to continuous development. You should update your device regularly to ensure that it is using the latest software.

 *It is recommended to create a backup before an update.*

Download the current software version from the Bender homepage and save it to your PC. Now connect the CP305 to the PC.

 *The parameterised IP address of the CP305 can be found in the device menu under Info.*

You will find the update option in the navigation in the web browser under  Tools > Service > Update. Follow the individual steps.

## 8 Factory settings for communication

The settings can be changed on the device or via the web user interface.

Parameter	Parameter
IP address	
IP address for 1:1 ETH connection	Address range (169.254.xx.yy) Note: xx and yy are derived from the MAC address during putting into service and are therefore unique for each CP305. This address cannot be changed.
Netmask	255.255.255.0
Standard gateway	192.168.0.1
DNS	192.168.0.1
DHCP	on
BMS address	1
BMS protocol	BMS i

## 9 Display and operation



*Operation with latex, vinyl and nitrile gloves is possible without restricting functionality.*

### LED and display

Display in **normal operation**: There are no warnings or alarms pending.

- The LED lights up green.
- The display shows the programmed default display screen (start page).



*You set parameters for the start page in the web operating application.*

Display when warning or alarm messages are pending

- The LED lights up red or in the colour assigned to the alarm.
- Depending on the type of error, the display yellow (“Warning”) or red (“Alarm”). The buzzer sounds at the same time. If the cause of the message cannot be remedied immediately, you can mute the buzzer with the “Acknowledge” button.
- Depending on the type of fault, the display has the colour assigned to the alarm. The buzzer sounds at the same time (if configured). If the cause of the message cannot be remedied immediately, the buzzer tone can be muted for the parameterised period of time with the “Acknowledge” button.
- The display shows details about the message. The message continues to be displayed visually until it is corrected.
- If there are several simultaneous messages, they are displayed alternately. The LED has the colour of the alarm with the highest priority.

### Header



Date and time

- Date and time (only if no large clock is created on the start page)

NFC logo

-  The NFC logo is only visible when the NFC interface is activated.

Lock

-  not logged in
-  PIN deactivated or PIN entered and logged in

≡ Menu

- See separate chapter

As long as you are not logged in to the device as an administrator, you can display the menu items but not make any changes and/or modify settings. Details can be found in the chapter “Settings on the device”.



Stopwatch active



Timer active



Device muted

## Footer



### Timer

- Setting range: 1 s to (10 h - 1 s)  
Resolution of setting 1 s
- A timer can be set and started on the default display screen. It counts down to 0 and signals the elapsed time interval with its buzzer. The timer can be paused as well as reset.
- The timer buzzer can be interrupted (with the "Mute" button).



### Stopwatch

- Value range (24 h - 1 s)  
Resolution of setting 1 s
- A stopwatch can be started on the default display screen. The timing can be interrupted. After the interruption, the timing can be continued or reset.



### Cleaning

- During mandatory cleaning, the display is blocked for user entries for 5 to 20 seconds (adjustable).

## TEST

- As soon as at least one test address has been created (using the web user interface), the button for starting the test appears.

## 10 Display CP305: Menu structure



*Normal state: The header and the LED are green when there is no alarm.  
In the event of an alarm, the header and LED take on the colour of the highest alarm level present.*

### 10.1 Measured values

- Digital inputs 1...12 and relays 1...2 show the measured value and current status.
- Display of date for the next service inspection

### 10.2 Bus overview

The bus overview shows the BMS bus addresses used with the connected devices. Because of the BMS bus cycle, it may take some time until all bus addresses are updated.



*In the web browser, this information is available in the system overview.*

Touching the device in the bus overview takes you to its detail page. Depending on the device, the individual channels, their alarm status and the current measured values are listed here.



*The BMS channels 1...12 are always displayed, even if they are not occupied.*

### 10.3 History

The warning and alarms are automatically stored in the history memory with dates and timestamps. 1000 text messages can be stored.

Each subsequent message overwrites the oldest message (message 1001 overwrites message 1 and so on).

Each entry in the list opens a pop-up with further information when touched.



*The history can also be found in the web user interface.  
Header > System > Menu ≡ > History*

**Detail pop-up of an entry in the history**

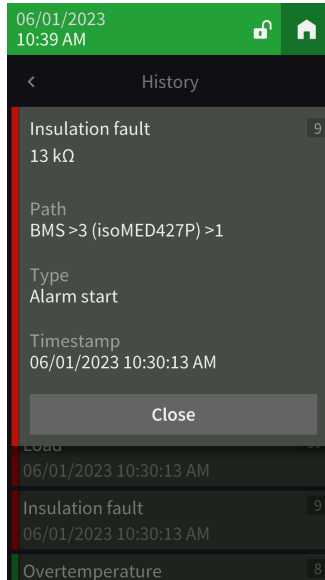

Element	Comments
Error category	Messages that come up are indicated in different colours, depending on their type, both on the display and in the stored history. Warnings: yellow Alarms: red Warning end, alarm end: green
Error designation	Device error DHCP error Digital input Voltage dips Insulation fault search Overtemperature Load Insulation fault Failure address
Number of the error message in the history	
Path specification	Address where the error occurred
Type	Alarm start, alarm end, error, device restart
Time stamp	Occurrence and end of the error



## 10.4 Alarm and test

### Alarm addresses

Display of the addresses/measuring channels whose alarm messages are assigned to the CP305.

The following are shown:

- BMS address/channel
- Device name
- Path to the alarm value
- Alarm group
- Buzzer on/off
- Buzzer profile
- Buzzer delay
- Relay on/off

The alarm addresses are configured in the web user interface.

### Alarm groups

Several measuring channels can be consolidated into one alarm group. The configuration is done in the web user interface.

### Test addresses

Display of the stored test addresses. The configuration is done in the web user interface.

You start the test by pressing the TEST button in the footer of the default display screen. Depending on the scope of the test, it may take a few minutes. The result is displayed after the test.



*The TEST button only appears if at least one test address has been set up.*

## 10.5 Settings

The settings of the CP305 are displayed here. You can adjust some device settings directly on the device if you log in.

Changed settings are highlighted in yellow. The changes are confirmed (green tick) or discarded (red X) in the header. You can make several changes at the same time on a single page. A pop-up window prevents you from leaving the page with unsaved changes.

### Digital inputs

Make settings for digital inputs IN1...12. Settings can be made channel by channel.

Mode

- Off
- High-active
- Low-active

t(on)

- The response delay indicates the delay with which the alarm is signalled.
- Setting range 0...600 s

t(off)

- The switch-off delay indicates how long an alarm needs to no longer be present before the message is also cancelled.
- Setting range 0...600 s

## Relays

Carry out operating principle and function for relays 1...2.

- Test Isometer (relay switches for approx. 30 seconds when a test of the assigned devices (insulation monitoring devices, LIM, GFCI) is triggered using the "TEST" button).
- Alarm addresses
- Buzzer (the relay switches as soon as the buzzer sounds. In this way, other signalling devices can be installed to indicate pending messages on the CP305.)
- N/C and N/O operation

## Interface

You can enter the settings for the various interfaces here. The current parameter settings are displayed.

Ethernet

- DHCP (on, off); IP address (DHCP)
- Manual: assign an IP address for the local network



*The automatically assigned IP address for a 1:1 connection cannot be changed.*

BMS

- Address (1...90)
- Interval (1...3 s)
- Acknowledgement via interface (on, off)

NFC



*NFC can only be activated for a certain time in order to carry out parameter settings.*

- Active (1 h, 12 h, off)
- End (timestamp when NFC is deactivated again)



*If the NFC interface is activated, this is indicated on the device with  in the header*

## Individual texts

Individually assigned texts such as device name and digital inputs are displayed but cannot be edited here. Changes are to be made using the web browser and are automatically applied.

## History

Delete the saved history in the device and in the web user interface. This step cannot be undone. If you want to save the history, use the web user interface to export it before deleting it.

## Date and time

Setting option for

- Time, date, time zone, daylight saving time
- Synchronisation with time server (SNTP) (auto DHCP, on, off)

## Display

General

- Language
- Alignment
- Cleaning mode active  
Setting option: deactivated or locked for 5...20 s

Alarm messages

- Set the time until the page is changed for several pending alarms.  
Setting range: 3/5/10 seconds

Standby mode

- Timeout (display) after 1...10 minutes
- Standby mode (automatic dimming, off, display time)
- Brightness "off", 10...90%



*In the event of an alarm, the display is always at 100% brightness. Only after the alarm has been eliminated does the CP305 go into standard operation with the configured standby mode.*

The display only shows most of the settings. You can make some settings as soon as the administrator has logged into the device with a PIN (factory setting 8070). The complete configuration takes place in the web browser.

## Security

Display

- PIN (enabled/diabled)
- Change PIN



*The display PIN for logging on to the device always consists of 4 digits.  
The factory setting for the PIN is 8070.  
If you forget the PIN, you can reset it in the web user interface.*

## Server

- *Administrator*
  - User name (display only)
  - Status (enabled, disabled)
  - Password (only \*\*\* is shown)
  - Read access (allow)
  - Write access (allow)
- *User*
  - User name (display only)
  - Status (enabled, disabled)
  - Password (only \*\*\* is shown)
  - Read access (display only)
  - Write access (display only)
- *Not logged in*
  - Read access (display only)
  - Write access (display only)

## Buzzer

### Setting options

- Volume (high, normal, low)
- Mute alarm (off, 1...8 h)
- End (mute) - date and time at which the mute is automatically cancelled again.
- When the device is muted, the LED and header turn blue. A note appears in the header (e.g. buzzer muted 1 h), along with the crossed-out loudspeaker icon .



*This setting is used for putting into service. It does not meet the requirements of the standard for audible alarms.*

## Service inspection



*During the service inspection, the system does not meet the requirements of the standard for audible and visual alarms.*

## Service interval

(deactivated, 3 months ... 4 years)

## Prewarning

(deactivated, 1 week ... 3 months) – message before the service interval expires so that plans can be made for the next inspection.

## Next service

(display only)

## Next service

Only displayed when a service interval is set.

## Last service

Date display on which date the last service check was carried out.

## Service inspection

The service inspection is started here.



*For the service inspection, it is necessary to first create at least one alarm address.*

### **Factory setting**

Restart device (Execute)

The device can be reset with or without interface settings.

- With interface: The device is reset to factory settings, and individual interface settings are discarded.
- Without interface: The device is reset to the factory settings, and individual interface settings are retained.

## **10.6 Info**

Display of the most important device parameters

- Device name
- Article number
- Serial number
- Firmware
- Bootloader
- BMS address
- IP address
- MAC address

## 11 Web user interface: menu structure (via ETH socket)

This chapter describes how to access the device through the IP address set for it. You will find it in the device menu > Info.

If you want to access the CP305 through a gateway, there is a limited range of functions when doing so.

In terms of your browser, we recommend using the latest versions of Google Chrome, Microsoft Edge or Mozilla Firefox. You need to activate JavaScript to use the functions of the web user interface. The pop-up blocker should be disabled for the IP address of the CP305.

*With Windows® Internet Explorer, it is necessary to always disable Compatibility View. Select Extras > Compatibility View Settings. Deactivate the button **Show intranet sites in the Compatibility View**.*

### Start page of the COMTRAXX® user interface

1. Open an Internet browser.
2. Enter the IP address of the CP305 on the address line (example: http://172.16.60.72).

	No.	Element
	1	Header
	2	Path indicator
	3	Navigation
	4	Subnavigation
	5	Content section
6	Alarm overview	

## 11.1 COMTRAXX® user interface





### 11.1.1 Header

Element	Description
	Click the logo: Return to the start page
CP305 COMTRAXX®	Device used: Device type
System x y 2023-01-16 09:47 (+01:00)	Device used: System name > Subsystem > Device address Date and time of the device
	The icon shows that the web user interface is protected by a password. Click the icon and then log in to enter the username and password
EN 	Language selection

Element	Description
	Open/close the navigation (button only available with small browser window)

 If you have forgotten the password, the Bender service can generate a one-time password. Have your serial number ready for this.



### 11.1.2 Navigation

	Menu	Description
	Start	Display information about the device and the software. Please have this information ready if you call to ask questions.
	System overview	In the system overview, all devices in the system are displayed either by subsystem or by interface. Pending alarms and operating messages are displayed. The CP305 can be configured.
	Alarms	Display of all pending alarms as well as the data of the alarming devices.
	Tools	Functions that affect the entire system

The navigation icons are visible on the left edge at all times. Even if you have just opened any other submenu of the web user interface, you can jump directly to one of the four sections by clicking the desired icon.

### 11.1.3 Subnavigation

The system overview is displayed in the subnavigation.

Element	Description
Search	Full text search in the system for device names or menu items. Found locations are highlighted in yellow.
	Close the expanded tree in the subnavigation
	Automatically expand: If active (= yellow), the displayed content of the content section is also shown in the subnavigation with automatically expanding device tree in addition to the path indicator. The path indicator and the content section are always synchronised. If switched off (= white), the subnavigation is not adapted to the path indicator or the current content section.
	- Sets whether the <b>view</b> is by subsystem or by interface. The interface display is only available with COMTRAXX® V4.xx and higher. - <b>Configure the row height</b> of the entries.

### 11.1.4 Content section

Display of the system, alarms and entries for the tools .

### 11.1.5 Alarm overview (footer)

#### Overview of pending alarms

Click the alarm overview: List of pending alarms

Click the list: Details of the alarms in the content section

#### History memory of the device

From the alarm overview, you can jump directly to the stored history of the CP305.

## 11.2 Start

Display of device info (device version, current software, serial number, order number, BCOM name)

### 11.3 System overview

 > System Overview > System







*With direct access via the ETH socket, the "System" is the CP305 itself.*

When you click the device "CP305", the following opens in the subnavigation:



- The device tools
- The menu of the device
- The BMS interface (as tile)

In the content section, there is an overview of the BMS interface, the set timers, the set service timer, the configured relays and the assigned digital inputs.







#### 11.3.1 Device tools

 Device tools		
	Document device	Here you can create documentation of the selected device as a pdf. By default the documentation contains all parameters and measured values associated with the device as well as device information such as serial number and software version. However, only one of these pieces of information can be selected if desired (see checkbox). The generated document reflects the current state of the device.
	Export backup	<p>The following data is part of a backup:</p> <ul style="list-style-type: none"> <li>- Menu parameters</li> <li>- Individual texts relating to the device</li> <li>- For devices of the COMTRAXX series, all relevant configuration files continue to be integrated</li> </ul> <p> <i>For security reasons, passwords are not part of a backup.</i></p> <p>In a user-defined backup, you can freely select which data from the device should be saved in it. You switch to the next step by pressing the "Next" button in the footer.</p>



	Import backup	You can import an existing backup here. All information in the backup is compared with the current information on the device. Then you can select the ones you want to import.   <i>Important: Please ensure in advance that the backup file is intended for the device!</i>  You switch to the next step by pressing the "Next" button in the footer.
--	---------------	---

### 11.3.2 Menu

 Menu		
	Measured values	Digital inputs IN1...12 Relay 1...2 Service inspection
	History	Up to 1000 entries can be stored. After that, the oldest data is overwritten (FIFO).   <i>The history entries can also be viewed on the CP305.</i>
	Settings	See chapter Settings
	Info	Device name, item number, serial no., firmware, bootloader, BMS address, IP address, MAC address   <i>This information can also be viewed on the CP305.</i>

### 11.3.3 BMS

The content section shows the connected BMS bus of the CP305. Clicking a device will cause the current measured values or alarms to be displayed.

## 11.4 Alarm overview (footer)

### Overview of pending alarms

Click the alarm overview: List of pending alarms

Click the list: Details of the alarms in the content section

### History memory of the device

From the alarm overview, you can jump directly to the stored history of the CP305.

## 11.5 Tools

### 11.5.1 Monitoring

#### 11.5.1.1 Device failure monitoring



*All devices whose failure is monitored are summarised here in a list.*

The CP305 can generate messages when a device on the BMS bus fails. To do this, the device must be included in the list of devices to be monitored.

 Tools > Monitoring > Device Failure Monitoring

You can add new entries using the “Add entry” button in the footer.

- **Add existing device**

A device already known to the system is to be added to the list. Navigate through the path indicator to the device to be monitored.

- **Add new device**

A device previously unknown to the system is to be added to the list. This requires that you enter the BMS address of the device to be monitored.

#### Import actual state

All active devices on the BMS bus are displayed as a list.

#### 11.5.1.2 Alarm addresses

##### Alarm groups tab

The alarm groups are created here first. Alarm addresses can then be assigned to them.



##### Alarm addresses tab

Alarms are defined here and configured as they are to be displayed. Each measuring channel can be selected as an alarm address and individually configured, such as the colour of the alarm pop-up, the help texts, the sounds, and so on. Each alarm can also be assigned to a previously created alarm group.

Each alarm address can display any combination of

- Collective alarm
- Device failure
- Measured value

#### Edit entries

	Show a preview of an alarm message
	Edit entry
	Delete entry

## Footer

- Import: Import configuration file of the alarm addresses (Excel file). \*
- Export: Export configuration file of the alarm addresses (Excel file)
- Import ACTUAL state
- Save changes
- Discard changes
- Add entry

\* Only configuration files that were previously exported from CP305 can be imported. Other Excel files (also exports from other CPx) are not supported.

### 11.5.1.3 Test addresses

#### Test addresses

Display the bus addresses that are to carry out a test when the “TEST” button is pressed on the device display. All test addresses are consolidated into one test group.



*Only ISOMETERS® can be tested.*

## 11.5.2 Device management

### 11.5.2.1 Start page

#### Configure the default display screen (start page)



The web user interface can be used to individually compile up to four entries on the start page.

#### Tools > Device Management > Start Page

You can create new entries using the “Add entry” button in the footer. The following options are available:

Type	Explanation
Measured value	Navigate to the source of the measured value via “Path”. An explanatory description can also be provided for the measured value displayed. The currently measured value and description are displayed.
Text	Enter any text you would like; this text will be displayed permanently.
Date and time	If the date and time in the header are too small, this allows you to create a large display. The display in the header then disappears.
Empty line	Blank lines allow the start page to be designed so that not everything is arranged in the upper section when there are less than four entries.

#### Edit entries

	Use the arrow keys to change the order of the entries.
	Edit entry
	Delete entry

## Footer

- Import: Import the start page configuration file (Excel file)
- Export: Export the start page configuration of as an Excel file
- Save changes
- Discard changes
- Add entry

## 11.5.3 Service

### 11.5.3.1 Update

Download a software update from the homepage. Save the file and follow the instructions in the web user interface.

### 11.5.3.2 Search for device

When you restart a device, it can take up to five minutes before all devices that are integrated into the system can be found and displayed. If devices continue to be missing, you can re-initialise the system.

 *Important note: Search for a device can briefly cause considerable data traffic on the network.*

### 11.5.3.3 Log files

Log files are saved as txt files. In the event of a fault, log files help Bender Service to more easily find the cause.

### 11.5.3.4 Device restart

The CP305 can be restarted from the web user interface without it being necessary to disconnect the CP305 from the power supply.

## 11.5.4 Information

- Link to the manual download on the Bender website
- Copyright information (including open source software used)

## 12 Web user interface: Settings (via ETH socket)

You need to save the changes before you quit the respective screen. Otherwise, the changes will be discarded.

### 12.1 Digital inputs 1-12

☰ Menu > Settings > Digital Input 1 - 12

For each of the 12 digital inputs IN1...12 can be set:

Parameter		Selection/setting range	Adjustable on CP305
Name	Designation of the measuring point	Text, up to 40 characters	—
Mode		Off High-active Low-active	✓
$t_{on}$	Active delay	0 s...10 minutes	✓
$t_{off}$	Switch-off delay		

An event is executed when the digital input experiences an edge change. The edge change must be present for a minimum of the set active delay  $t_{on}$ ; otherwise, it is ignored.

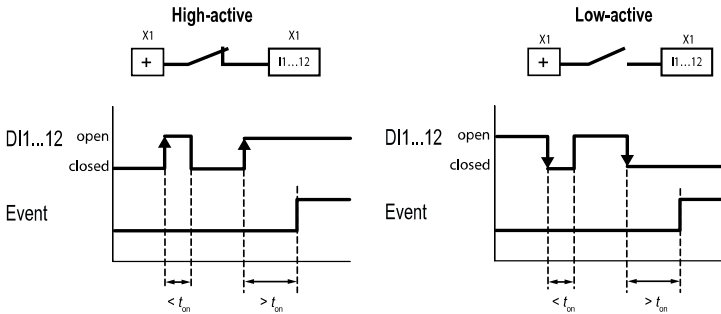

## 12.2 Relays 1-2

☰ Menu > Settings > Relay

Carry out operating principle and function for relays 1...2.

Operating principle	Function
Normally open / Normally closed	Alarm addresses
	Buzzer
	Alarm addresses   Buzzer
	Test Isometer

- Alarm addresses: Relay responds to each alarm address created. This is independent of whether the relay has been individually parameterised in the alarm addresses.
- Buzzer: The relay switches as soon as the buzzer sounds. In this way, other signalling devices can be installed to indicate pending messages on the CP305.
- Alarm addresses | Buzzer: Relay switches when either an alarm address or the buzzer is active.
- Test Isometer: (relay switches for approx. 30 seconds when a test of the assigned devices (insulation monitoring devices, LIM, GFCl) is triggered using the "TEST" button).

## 12.3 Interface

☰ Menu > Settings > Interface

The parameters required for each connected interface are set here:

### Ethernet

Make Ethernet settings. The parameterised IP address is displayed.

If DHCP is switched off, the IP address must be set manually.

### BMS

Address (1...90)

Interval (1...3 s)

Acknowledgement via interface (on, off)

### NFC

Active (off, 1 h, 12 h)

If NFC is activated, the time of automatic deactivation is shown.

**i** If the NFC interface is activated, this is indicated on the device with  in the header.

## 12.4 Individual texts

**i** The individual texts assigned here are displayed on the CP305 but cannot be adjusted there. Because individual texts are not transmitted via the BMS bus, they are not available on other devices.

## Device

Configure the displayed device name. Saved changes are immediately applied to the CP305.

- i** *The individual device name is appended to the device type in the history.  
Example: Device name "Room 4.2.3 Window" is listed in the history as "CP305-IO – Room 4.2.3 Window".  
You do not need to include the device type here.*

## Digital inputs

Provide the 12 digital inputs DI1...12 (measuring points) with description text

- i** *The designations of the digital inputs can also be assigned in the settings of the digital inputs.  
Menu > Settings > Digital inputs 1...12  
Both places are automatically synchronised with each other.*

## 12.5 History

Delete the saved history in the device and in the web user interface. This step cannot be undone.

- i** *If you want to save the history, **export the history before deleting** it under Menu > History > Export in the web user interface.*

## 12.6 Clock

Setting option for

- Time, date, time zone, daylight saving time
- Synchronisation with time server (SNTP) (auto DHCP, on, off)

## 12.7 Display

General

- Language
- Alignment
- Cleaning mode active  
Setting option: deactivated or locked for 5...20 s

Alarm messages

- Set the time until the page is changed for several pending alarms.  
Setting range: 3/5/10 seconds

Standby mode

- Standby mode (off, auto dim, display time)
- Timeout (display) after 1...10 minutes
- Brightness "off", 10...90%

- i** *In the event of an alarm, the display is always at 100% brightness. Only after the alarm has been eliminated does the CP305 go into standard operation with the configured standby mode.*

## 12.8 Security

The PIN for logging in to the device and the password for logging in to the web user interface are independent of each other.

## Display



*The PIN for logging in to the device consists of 4 digits.  
The factory setting is "8070".*

- PIN (enabled/disabled)
- PIN (change PIN)

## Server



*The password for the web user interface is alphanumeric.  
The factory setting is "admin".*

- Administrator (user name admin)  
Status (enabled/disabled)  
Password (only \*\*\* is displayed)  
Username (display only)  
Write access (display only)  
Read access (display only)
- User (username user)  
Status (enabled/disabled)  
Password (only \*\*\* is displayed)  
Username (display only)  
Write access (display only)  
Read access (display only)
- Not logged in  
Write access (display only)  
Read access (display only)

## 12.9 Buzzer

### Setting options

- Volume (low, normal, high)
- Mute alarm (off, 1...8 h)

End date (mute alarm): Display of date and time at which the mute is automatically cancelled.

When a mute is set, the LED and header on the device turn blue. A message (e.g. Buzzer off 1 h) and the icon of a crossed-out loudspeaker  appear in the device header.



*During muting, the system does not meet the normative requirements for audible and visual alarms.*

## 12.10 Service inspection

### Service interval



*During the service inspection, the system does not meet the requirements of the standard for audible and visual alarms.*

### Service interval

(deactivated, 3 months ... 4 years)



**Prewarning**

(deactivated, 1 week ... 3 months) – message before the service interval expires so that plans can be made for the next inspection.

**Next service**

(display only)

**Service inspection****Next service**

Only displayed when a service interval is set.

**Last service**

Date display on which date the last service check was carried out.

**Service inspection**

The service inspection is started here.



*For the service inspection, it is necessary to first create at least one alarm address.*

## 12.11 Factory setting

**Restart device:** Perform a restart without having to disconnect the CP305 from the power supply.







**Factory settings with interface:** The device is reset to the factory settings, and individual interface settings are discarded.

**Factory settings without interface:** The device is reset to the factory settings, and individual interface settings are retained.

## 13 Web user interface: Menu structure (access via gateway)

If the CP305 is connected to a CP9xx control panel or a COM465 gateway or the like, a device menu of the CP305 can be opened. This can be used to call up device information.

### 13.1 Device tools

 Device tools	
	<p><b>Document device</b></p> <p>Here you can create documentation of the selected device as a pdf. By default the documentation contains all parameters and measured values associated with the device as well as device information such as serial number and software version. However, only one of these pieces of information can be selected if desired (see checkbox). The generated document reflects the current state of the device.</p>
	<p><b>Export backup</b></p> <p>The following data is part of a backup:</p> <ul style="list-style-type: none"> <li>- Menu parameters</li> <li>- Individual texts relating to the device</li> <li>- For devices of the COMTRAXX series, all relevant configuration files continue to be integrated</li> </ul> <p> <i>For security reasons, passwords are not part of a backup.</i></p> <p>In a user-defined backup, you can freely select which data from the device should be saved in it.</p> <p>You switch to the next step by pressing the "Next" button in the footer.</p>
	<p><b>Import backup</b></p> <p>You can import an existing backup here. All information in the backup is compared with the current information on the device. Then you can select the ones you want to import.</p> <p> <i>Important: Please ensure in advance that the backup file is intended for the device!</i></p> <p>You switch to the next step by pressing the "Next" button in the footer.</p>

## 13.2 Menu

### 13.2.1 Edit texts

You need to be logged in to the device to create and change individual texts. Changes are saved or discarded in the footer.

#### Device

This defines how the device is designated in the system.

- Device name (important for setting alarm address parameters, for example)
- Device failure

### **Channel 1 - 12**

For each of the channels 1...12 (digital inputs), custom message texts can be assigned for:

- Description
- Warning
- Prewarning

### **13.2.2 Info**

Display of

- Device type
- Software
- producer
- Website

## 14 Export and import of device data

Different device data can be exported via the web user interface. They are exported in the appropriate format depending on the application.

 You will find the files in the Download folder of your computer.

Likewise, these files can also be imported back into the CP305 (except pdf).

### Export as pdf

 System Overview > System > Device Tools > Document Device

### Export/Import as json file

 System Overview > System > Device Tools > Export Backup

During import, the contents of the backup file are compared with the currently configured data. The values to be adopted can be individually selected or deselected.

### Export/Import as Excel file

 Tools > Monitoring > Alarm Addresses (export without any setting options)

 Tools > Device Management > Start Page (export without any setting options)

 Tools > Device Management > Individual Texts

The Excel files created can be edited with the usual Excel tools. In the workbook, there is a separate "Help" worksheet in which the structure and permitted contents of the cells are explained.

 *Expert mode: parameters can be easily set for CP305 using the Excel files ("Quick programming"). Recommended for experienced administrators only.*

## 15 Cleaning, servicing and troubleshooting

### 15.1 Cleaning

The glass front can be wiped clean with common cleaning agents. The glass and seal are resistant to alcohol-based disinfectants.

### 15.2 Servicing

The device does not contain any parts that require servicing. Despite this, the intervals specified for periodic verification should be adhered to.

### 15.3 Error messages

The CP305 indicates parameterised and detected errors on the display; if set to do so, the buzzer also signals the errors.

If the function "Relay active" is set under  Tools > Monitoring > Alarm addresses, the alarm relay also switches.

### 15.4 LED

The LED on the CP305 indicates the status or alarm mode:

LED colour	Meaning
Off	No power supply; the device is not ready for operation.
Lights up green	The device is in standard mode; no messages are present at the configured alarm addresses.
Lights up red	An alarm message (allocated in red) is present on at least one configured alarm address.
Lights up blue	The device is muted.
Lights up yellow	An alarm message (allocated in yellow) is present on at least one configured alarm address.
Flashes red	Power supply lost.
Flashes violet	The device boots.

 *During the alarm, the LED takes on the colour assigned in each case. Green, yellow, red, blue and violet are available.*

 *If several alarms are present at the same time, the LED takes on the colour of the highest-priority alarm.*

## 15.5 Malfunctions

List of possible errors and proposals for the correction of the faults. This error list does not claim to be exhaustive.

Error	Possible cause/actions
No indication on the display of the CP305	Check the AC/DC 24 V power supply.
No indication on the display, but the display is illuminated.	Replace CP305
LEDs do not light up	Replace CP305
Time is reset to zero in case of short-term voltage failure.	Replace CP305
Error on internal BMS bus	Address of devices incorrectly set on internal bus; interface lines A/B are interchanged; the network was incorrectly or not terminated; faulty parameter setting
Digital input function error	Digital inputs not correctly set. Defective connection (does not match pre-assignment). Incorrect setting "neutral/medical".

## 15.6 Recurring inspections

The following periodic verification must be performed on electrical installations in compliance with the local or national regulations that apply. For your Bender products, we recommend:

Action	Carried out by	Interval
Functional test of the IT system monitoring (insulation, load current, transformer temperature and connection monitoring): Press the "TEST" button on the device display once; close the pop-up when finished.	Med. personnel	Once every working day
Functional test of the changeover device*: functional test of the automatic transfer switching devices. The instructions in chapter "Test of the changeover device" (changeover device manual) must be observed.	Electrically skilled person	Every 12 months
Functional test of the IT system monitoring (insulation, load current, transformer temperature and connection monitoring) on the insulation monitoring device.	Electrically skilled person	Every six months
Checking the setting values and changeover periods.	Electrically skilled person	Every 12 months

Action	Carried out by	Interval
Test the changeover device, the IT system monitoring, and the connection to the SCADA system (Supervisory Control and Data Acquisition) (if applicable) as well as the interaction between the components in the system. The test encompasses the following: <ul style="list-style-type: none"> <li>– <b>Inspection:</b> Marking, display elements, mechanical components, wiring, parameter setting, connection of third-party systems, evaluation of fault memory</li> <li>– <b>Measurement:</b> Internal/external supply voltages/potentials, bus voltage, bus protocol, bus scan</li> <li>– <b>Testing:</b> Device function, device communication</li> <li>– <b>Documentation:</b> Test results, recommendations for eliminating defects</li> </ul>	Bender	Every 24 months

\* *This test must only be performed by an authorised electrically skilled person in agreement with the medical locations concerned.*

Before carrying out the tests, please refer to the instructions relating to the functional tests in the checklist. If no national directives apply, you should perform the tests recommended by DIN VDE 0100-710 (VDE 0100-710).

## 16 Technical data

The CP305 is intended for use in basic (DIN EN 61326-1, Table 1) and industrial (DIN EN 61326-1, Table 2) electromagnetic environments.

### 16.1 Tabular data

()\* = factory setting

Insulation coordination CP305 acc. to IEC 60664-1

Rated voltage	50 V
Overtoltage category	II
Pollution degree	2

Overtoltage category II and pollution degree 2 is related to the relay contacts. Further insulation coordination takes place after functional separation.

Supply via plug-in terminal (A1/+, A2/-)

Rated voltage	AC/DC 24 V
Operating range of the supply voltage	AC 18...28 V/DC 18...30 V
Nominal frequency	50/60 Hz
Typical power consumption	< 4.2 W

Maximum cable length with supply via B95061210 (24 V DC power supply unit 1.75 A)

0.28 mm <sup>2</sup>	75 m
0.5 mm <sup>2</sup>	130 m
0.75 mm <sup>2</sup>	200 m
1.5 mm <sup>2</sup>	400 m
2.5 mm <sup>2</sup>	650 m

Stored energy time in the event of voltage failure

Time, date	Min. 2 days
Restart after power failure	Min. 2 seconds

Displays, memory

Display	5" TFT touch display (720 x 1280 px)
Displayable devices	90
Number of alarm addresses	500
Number of test addresses	50



## Displays, memory

Number of history memory entries	1000
----------------------------------	------

**Interfaces**

## Ethernet

Connection	RJ45
Data rate	10/100 Mbit/s, autodetect
DHCP	on/off (on)*
IP address (1:1 connection)	169.254.xx.yy (xx and yy are unique for each device)
Netmask	nnn.nnn.nnn.nnn (255.255.255.0)*
Logs	TCP/IP, Modbus TCP, DHCP, SNTP

## Modbus TCP

Interface/protocol	Ethernet/Modbus TCP
Operating mode	Slave

## BMS bus

Interface/protocol	RS485/BMS internal
Operating mode	Master/slave (master)*
Baud rate	9.6 kBit/s
Cable length	< 1200 m
Shielded cable, one end of shield connected to PE	Recommended: CAT6/CAT7 min. AWG23 Alternative: J-Y(St)Y min. 2 x 0.8
Galvanic separation	Yes
Connection	"BMS A", "BMS B" (see plug-in terminal)
Terminating resistor	120 Ω (0.25 W), can be connected internally
Device address	1...90 (1)*

## Digital inputs (1...12)

Number	12
Galvanic separation	In groups of four IN 1...4 / GND 1-4 IN 5...8 / GND 5-8 IN 9...12 / GND 9-12
Relay mode	Can be selected for each input: high-active or low-active

Digital inputs (1...12)

Factory setting	Off
Voltage range (high)	AC/DC 10...30 V Nominal: 24 V
Voltage range (low)	AC/DC 0...2 V
Max. current per channel (at AC/DC 30 V)	8 mA
Connection	Plug-in terminals IN 1... 4 / GND1-4 IN 5...8 / GND 5-8 IN 9...12 / GND 9-12
Maximum cable length	< 500 m

Switching elements

Connection	Plug-in terminal K1 NC; K1 NO; K1 COM K2 NC; K2 NO; K2 COM
Number of changeover contacts	2
Operating principle (changeover contacts)	N/C operation / N/O operation
Function	Programmable
Electrical endurance under rated operating conditions	10,000 operating cycles

Contact data acc. to IEC 60947-5-1

Utilisation category	AC-13	AC-14	DC-12
Rated operational voltage	AC 24 V	AC 24 V	DC 24 V
Rated operational current	AC 2 A	AC 2 A	AC 2 A

Buzzer

Buzzer alarm	Can be acknowledged, adoption of characteristics of new value, can be muted
Buzzer interval	Configurable
Buzzer frequency	Configurable
Buzzer repetition	Configurable

**Device connections**

Plug-in terminal (A1/+, A2/-)

Conductor sizes	AWG 24...12
Stripping length	10 mm
Rigid/flexible	0.2...2.5 mm <sup>2</sup>
Flexible with ferrules, with/without plastic sleeve	0.25...2.5 mm <sup>2</sup>
Multiple conductor flexible with TWIN ferrule with plastic sleeve	0.5... 1.5 mm <sup>2</sup>

Plug-in terminals

(BMS A, BMS B), (IN1...4, GND1...4, IN9...12, GND9...12) (IN5...8, GND5...8, K1..., K2...)

Conductor sizes	AWG 18...16
Stripping length	10 mm
Rigid/flexible	0.75...1.5 mm <sup>2</sup>
Flexible with ferrule without plastic sleeve	0.75... 1.5 mm <sup>2</sup>
Flexible with ferrule with plastic sleeve	0.75 mm <sup>2</sup>

For UL applications

Use copper lines only.

Minimum temperature range of the cable to be connected to the plug-in terminals

75 °C

Environment/EMC

EMC	IEC 61000-6-2:2016-08 Ed. 3.0 IEC 61000-6-3:2020-07 Ed. 3.0 IEC 61326-1:2020-10 Ed. 3.0 DIN EN 61326-1:2020-10 Ed. 3.0 DIN EN 61326-1:2013-07 DIN EN 50364:2019-05 EN 300 330 V2.1.1 ETSI EN 301 489-3 V2.3.0
Operating temperature	-10...+55 °C
Operating temperature for UL applications	-10...+50 °C
Operating altitude	≤ 2000 m AMSL
Rel. humidity	≤ 98 % at 25 °C

Classification of climatic conditions acc. to IEC 60721

Stationary use (IEC 60721-3-3)	3K22
Transport (IEC 60721-3-2)	2K11
Long-term storage (IEC 60721-3-1)	1K22

Classification of mechanical conditions acc. to IEC 60721

Stationary use (IEC 60721-3-3)	3M11
Transport (IEC 60721-3-2)	2M4
Long-term storage (IEC 60721-3-1)	1M12

Other

Operating mode	Continuous operation
Mounting position	Display-oriented, adjustable horizontal/vertical display orientation
Degree of protection of front glass pane	IP66
Degree of protection of front for UL applications	IP50
Degree of protection of enclosure	IP20
Flammability class	UL 94V-0
Device dimensions (W x D x H)	181 x 96 x 37.31 mm
Weight	< 420 g

()\* = Factory setting

## 16.2 Standards and approvals



## 16.3 Ordering information

### Device variants

Type	Description	Art.-No.
CP305-IO		B95100051
CP305-C	Customised parameter settings	B22030051

**Accessories**

Type	Description	Art.-No.
Flush-mounting enclosure		B923710
Cavity wall installation set for flush-mounting enclosure	Installation set for flush-mounting enclosure B923710	B923711
CP305 surface-mounting enclosure		B95100153
CP305-IO plug kit	CP305-IO connector kit	B95100151
Ethernet adapter kit (RJ45 socket insert, Cat.6 SLIM patch cable)	Ethernet connector kit	B95100152

**16.4 Document revision history**

Date	Document version	State/Changes
09.2022	00	First edition
01.2023	01	<i>Editorial revision/corrections</i> of texts, figures, technical data, ordering information
07.2023	02	<i>Added</i> Ordering information CP305-C

## **17 EU Declaration of Conformity**

Bender GmbH & Co. KG hereby declares that the device covered by the Radio Directive complies with Directive 2014/53/EU. The full text of the EU Declaration of Conformity is available at the following Internet address:

[https://www.bender.de/fileadmin/content/Products/CE/CEKO\\_CP3xx.pdf](https://www.bender.de/fileadmin/content/Products/CE/CEKO_CP3xx.pdf)





**Bender GmbH & Co. KG**

Londorfer Straße 65  
35305 Grünberg  
Germany

Tel.: +49 6401 807-0  
info@bender.de  
www.bender.de

Alle Rechte vorbehalten.  
Nachdruck und Vervielfältigung nur mit  
Genehmigung des Herausgebers.

All rights reserved.  
Reprinting and duplicating only with  
permission of the publisher.



© Bender GmbH & Co. KG, Germany  
Subject to change! The specified  
standards take into account the edition  
valid until 07.2023 unless otherwise  
indicated.